

TYPICAL ELEVATION WITH FASTENER SPACING

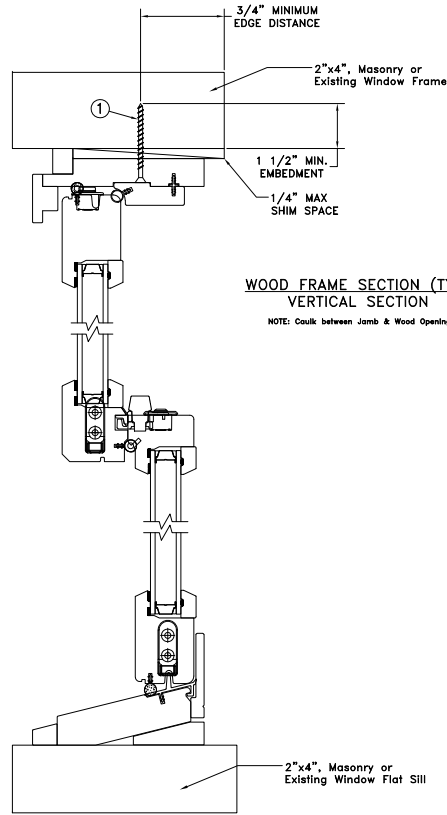

WOOD FRAME SECTION (TYP)  
VERTICAL SECTION

NOTE: Caulk between Jamb & Wood Opening.

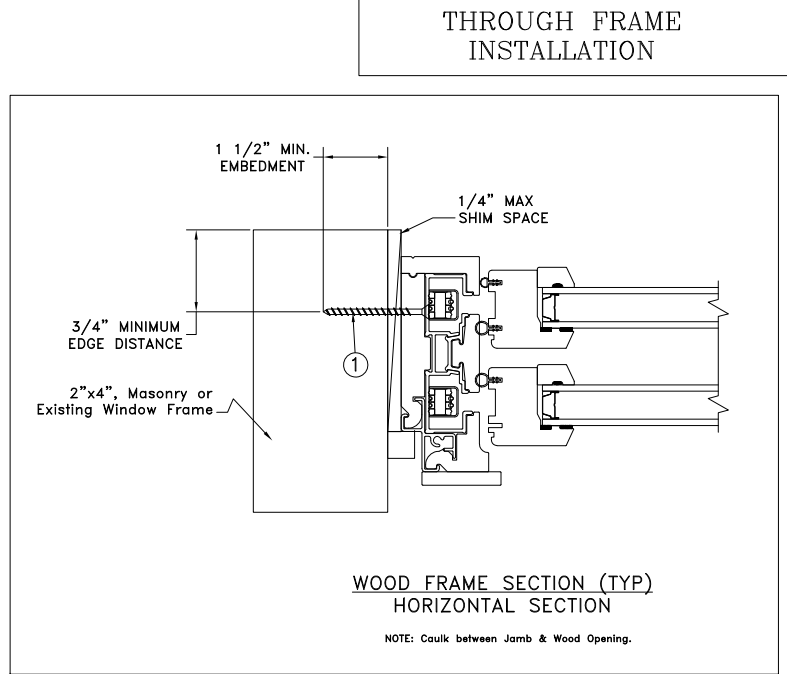

WOOD FRAME SECTION (TYP)  
HORIZONTAL SECTION

NOTE: Caulk between Jamb & Wood Opening.

Max Frame	DP	IMPACT
45 3/8 x 59 7/32	+50/-55	NO

**Installed Fastener Schedule:**

1. All windows: install corrosion resistant #8 fasteners no more than 4" from each corner and 16" o.c. through pre-drilled holes in the head and side jambs of the window.
2. Fasteners must be long enough to penetrate at least 1-1/2" into framing members.

**General Notes:**

1. The product shown herein is designed and manufactured to comply with the current edition of the Florida building code.
2. Buck, framing and masonry by others and is responsibility of architect or engineer of record
3. All glazing shall conform to ASTM E1300.

This schedule addresses only the fasteners required to anchor the unit to achieve the rated design pressure and impact performance (where applicable) up to the size limitations noted. It is not intended as a guide to the installation process and does not address the sealing consideration that may arise in different wall conditions. For the complete installation procedure, see the instructions packaged with the unit or go to [www.jeld-wen.com](http://www.jeld-wen.com).

**DISCLAIMER:**

This drawing and its contents are confidential and are not to be reproduced or copied in whole or in part or used or disclosed to others except as authorized by JELD-WEN Inc.

DRAWN BY: <b>J.HAWKINS</b> CHECKED BY: <b>R.HAMILTON</b> APPROVED BY: <b>D.STOKES</b> PART/PROJECT No.: <b>D015188</b> IDENTIFIER No. -	DATE: <b>06/20/2018</b>	<b>JELD-WEN</b> 3737 LAKEPORT BLVD. KLAMATH FALLS OR, 97601 PHONE: (800) 535-3936	
	SCALE: <b>NTS</b>		
	TITLE: <b>Siteline Wood Pocket Double Hung</b>		
	CAD DWG. No.: SitelineWDPKTDH Cert	REV: <b>A</b>	SHEET